

REP. NEW PATIENT RM TOILET PLAN
3/8"=1'-0"

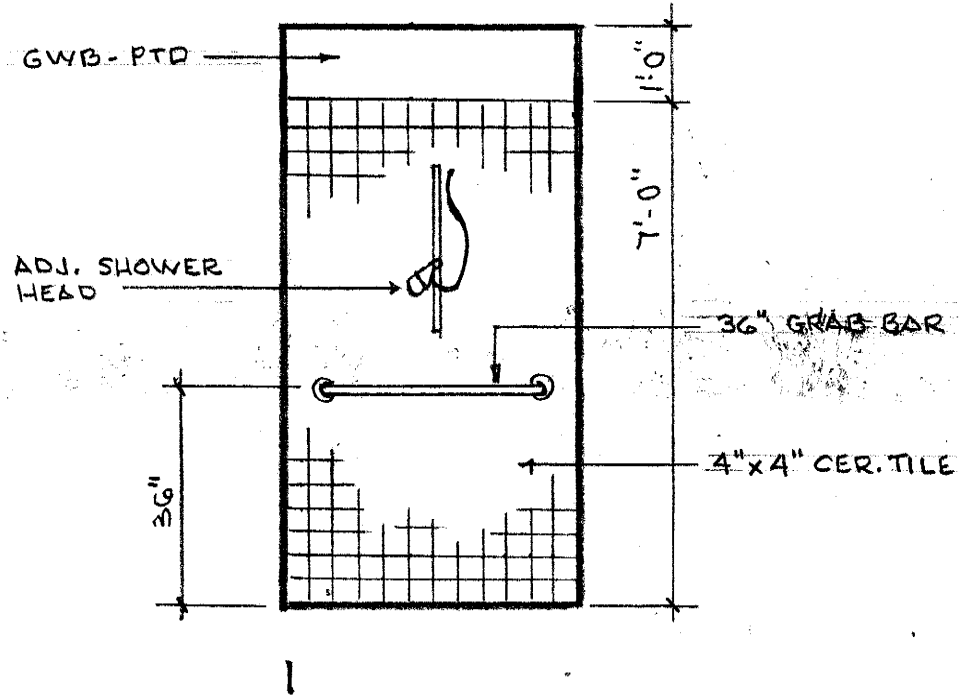

1

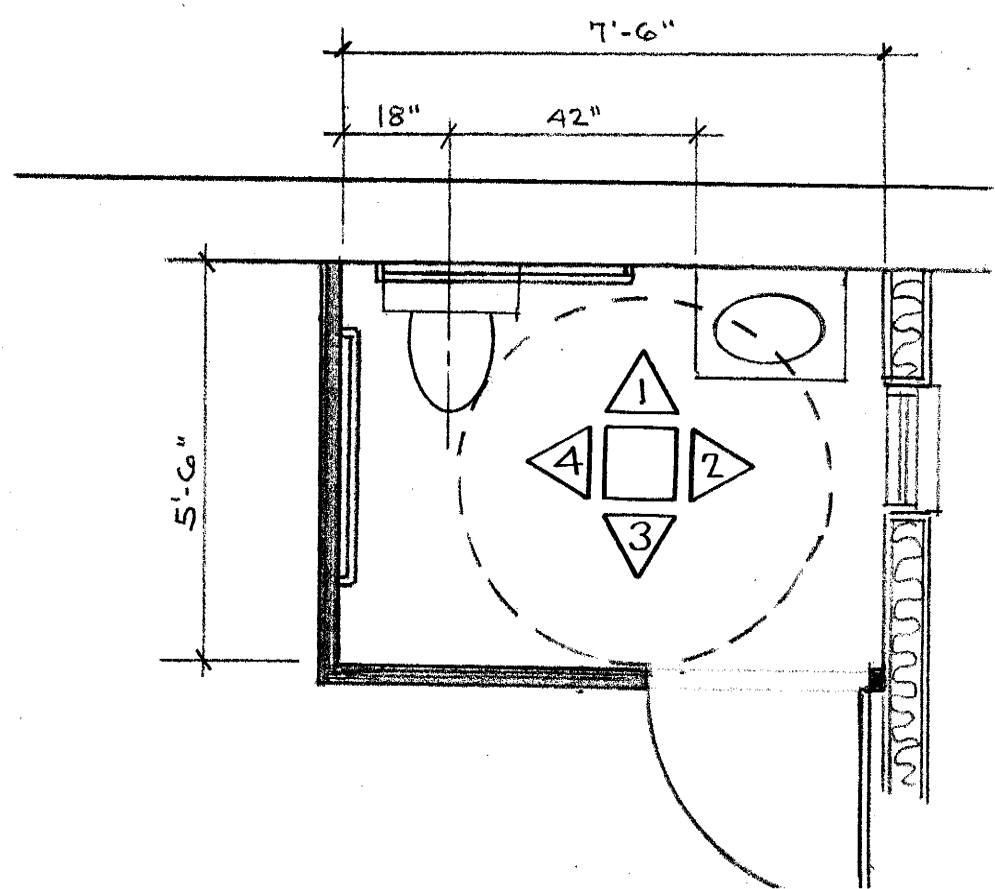
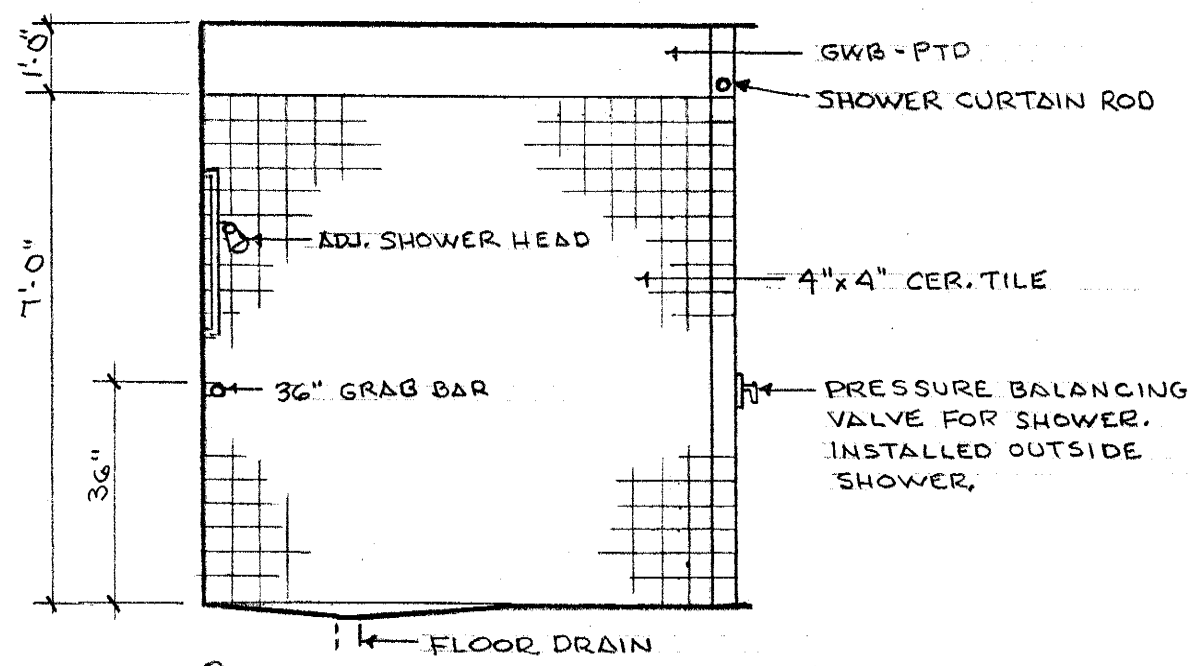

2

BATHING AREA SHOWER ELEVATIONS
3/8"=1'-0"

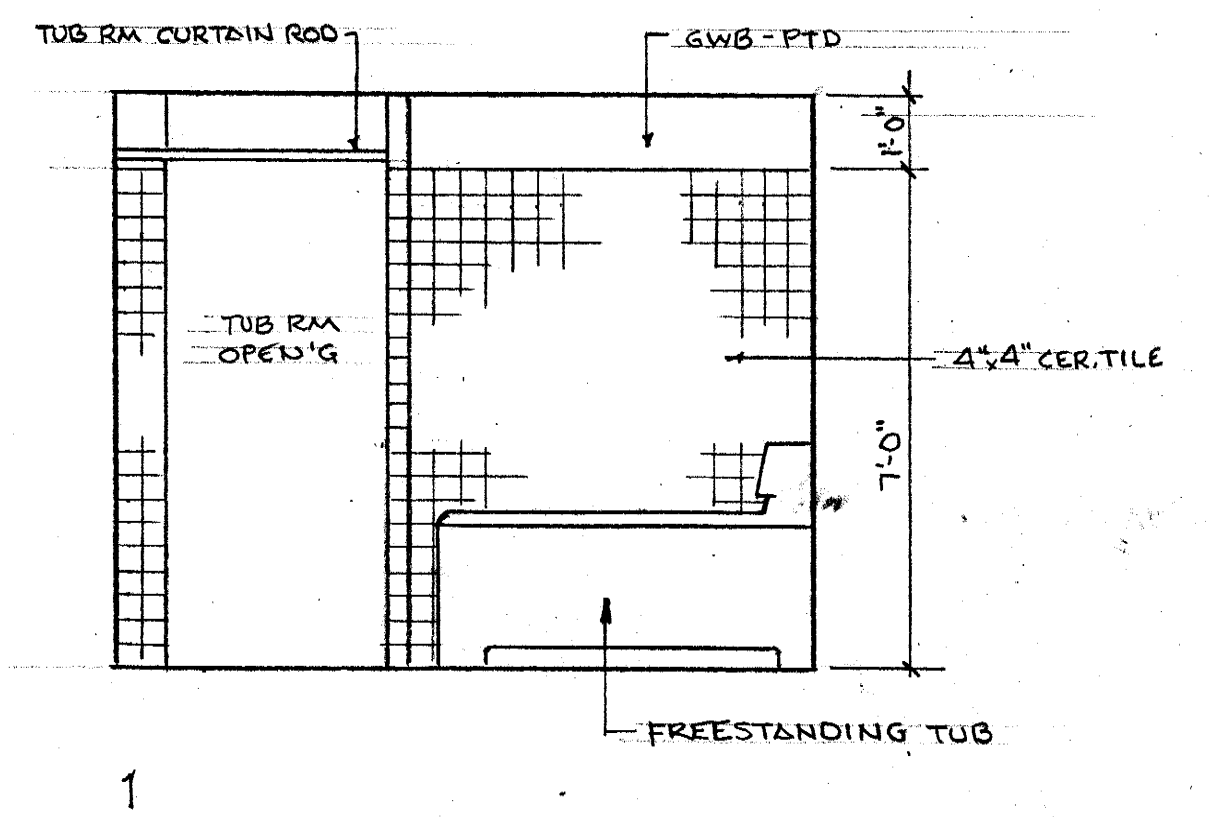

1

TUB ROOM ELEVATIONS 3/8"=1'-0"

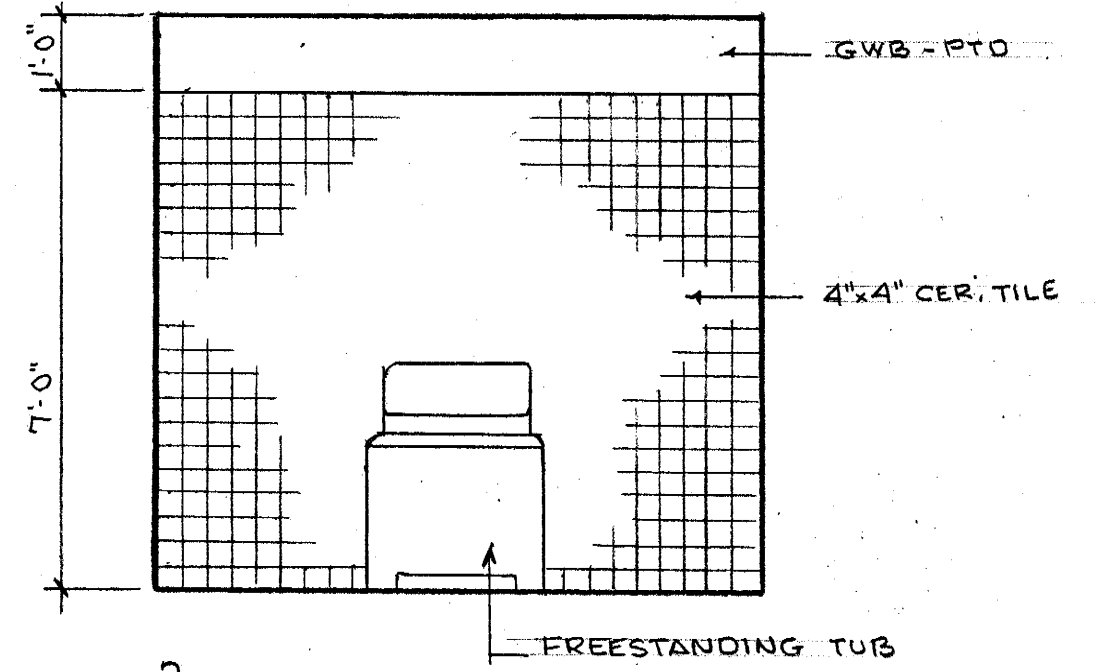

2

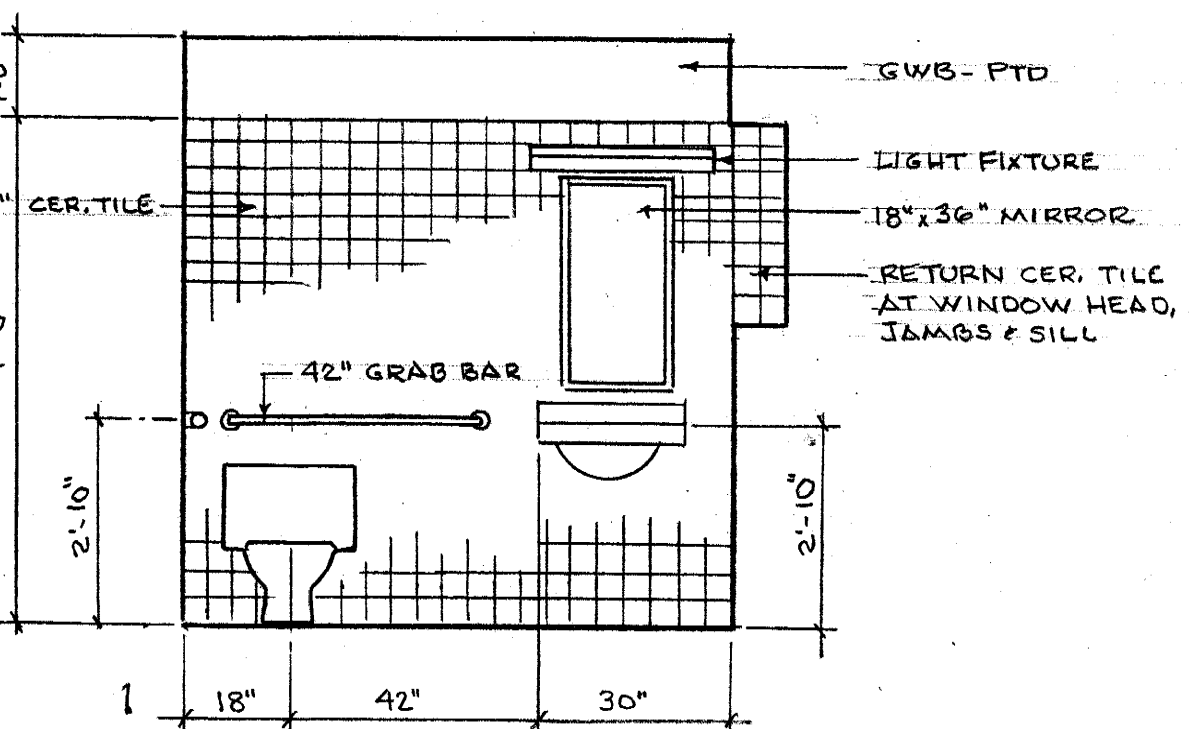

REP. NEW PATIENT RM TOILET ELEVATIONS
3/8"=1'-0"

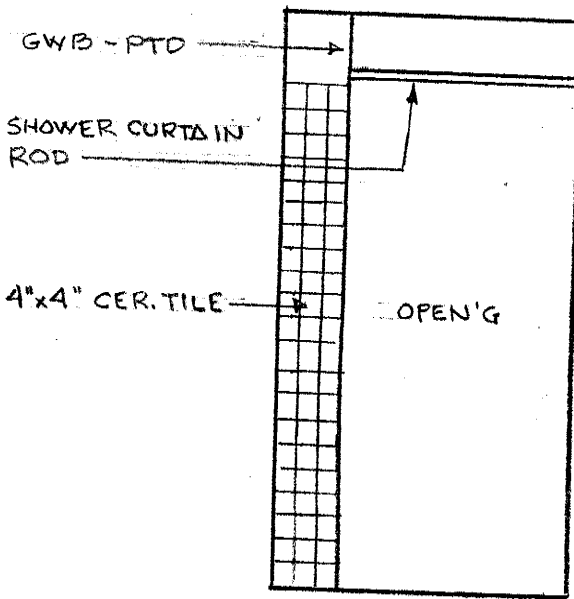

3

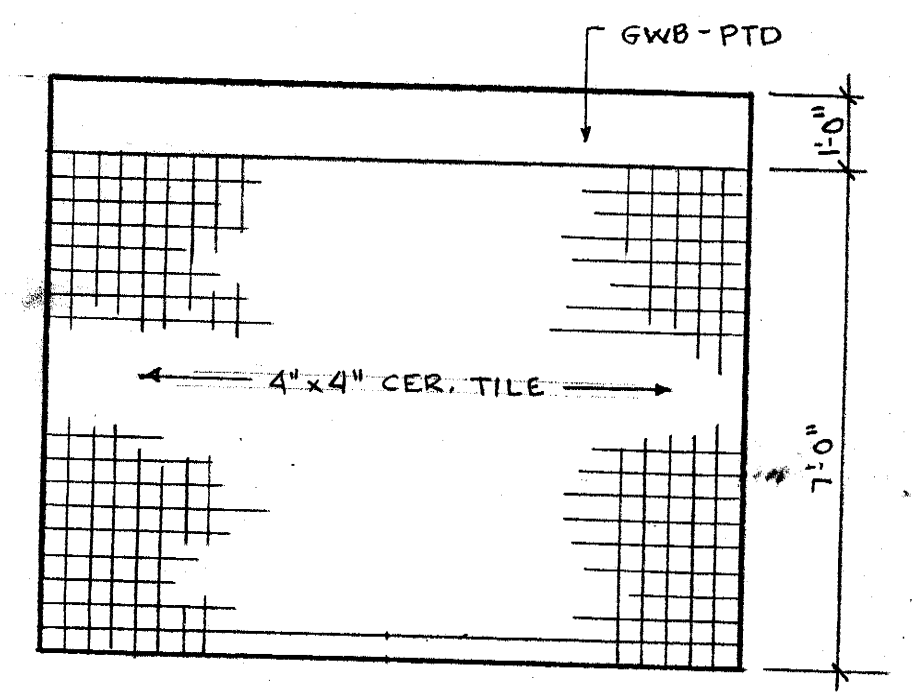

3

TUB ROOM ELEVATIONS 3/8"=1'-0"

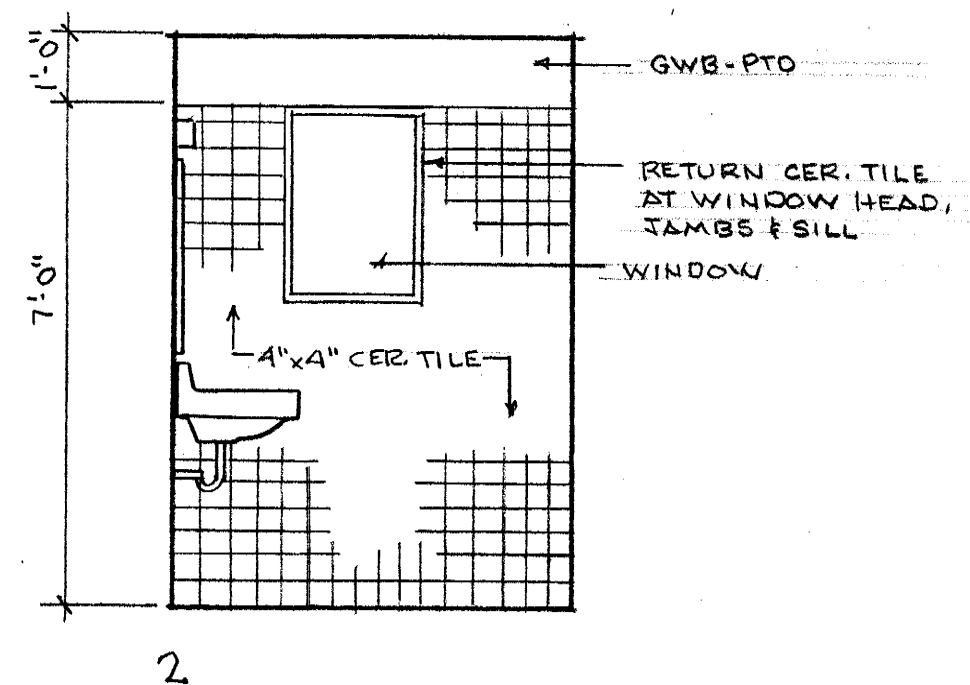

2

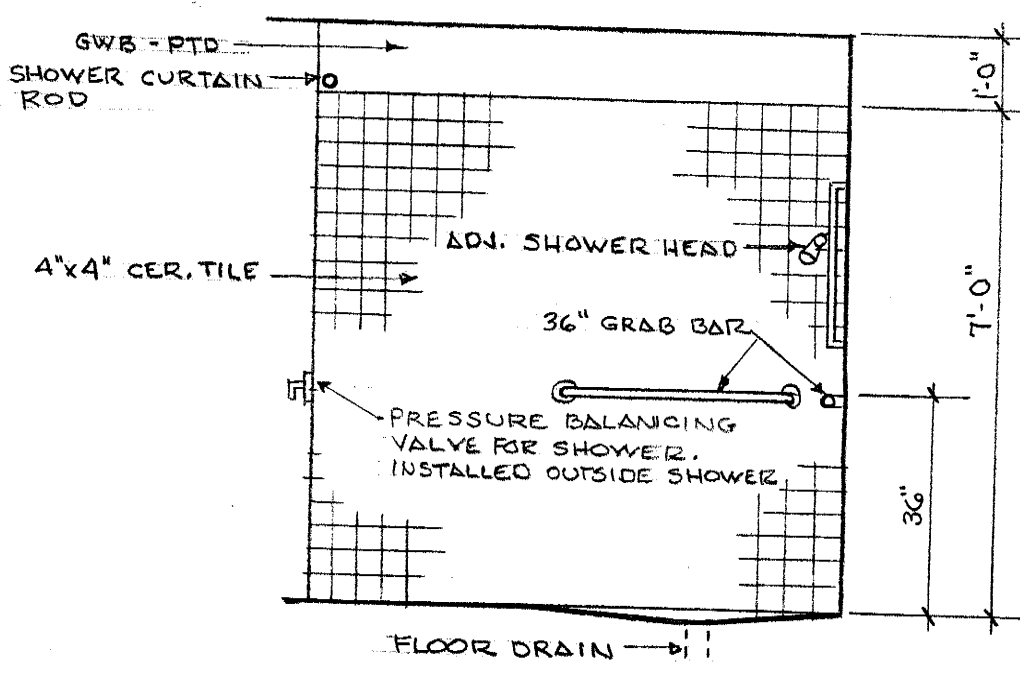

4

BATHING AREA SHOWER ELEVATIONS
3/8"=1'-0"

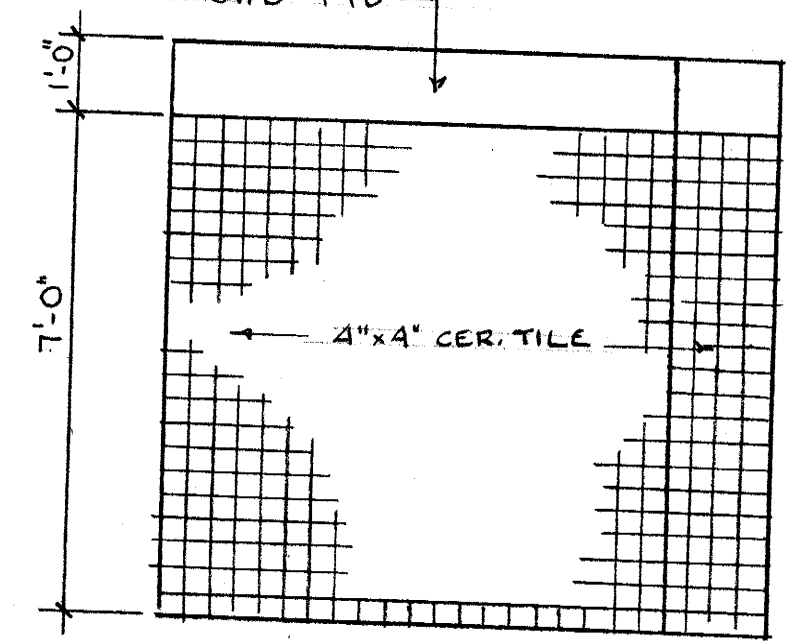

4

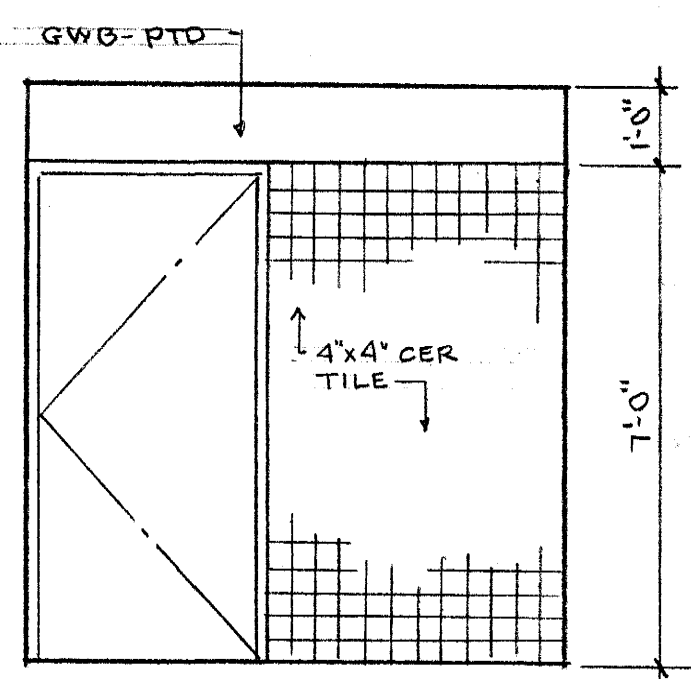

3

REP. NEW PATIENT RM TOILET ELEVATIONS
3/8"=1'-0"

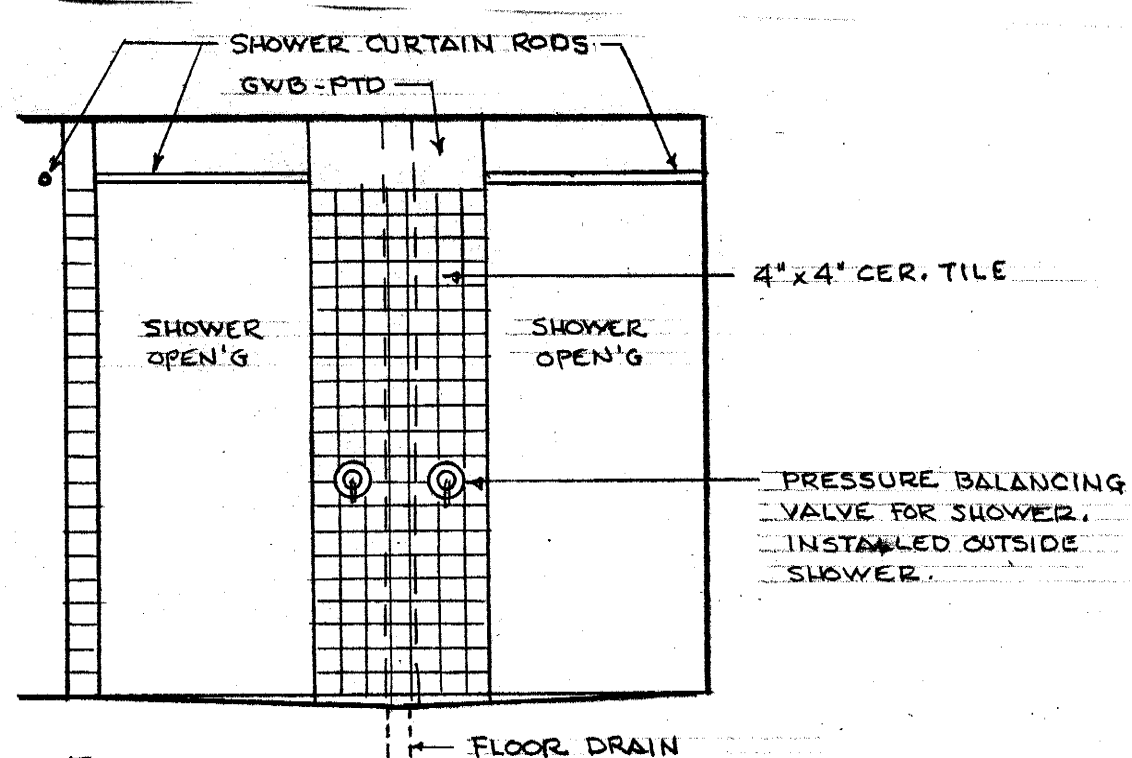

5

BATHING AREA SHOWER ELEVATIONS
3/8"=1'-0"

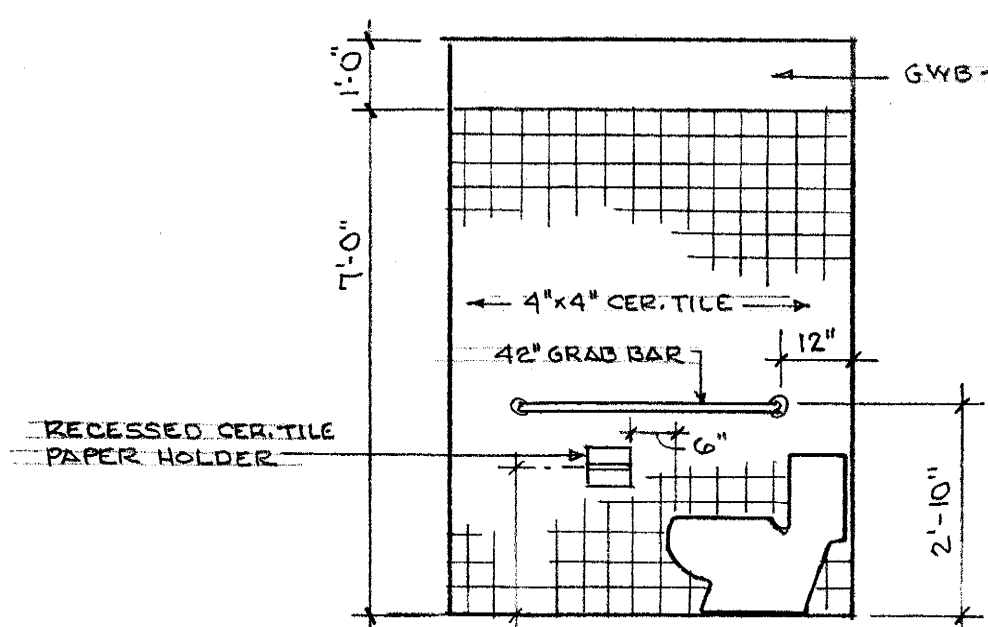

4

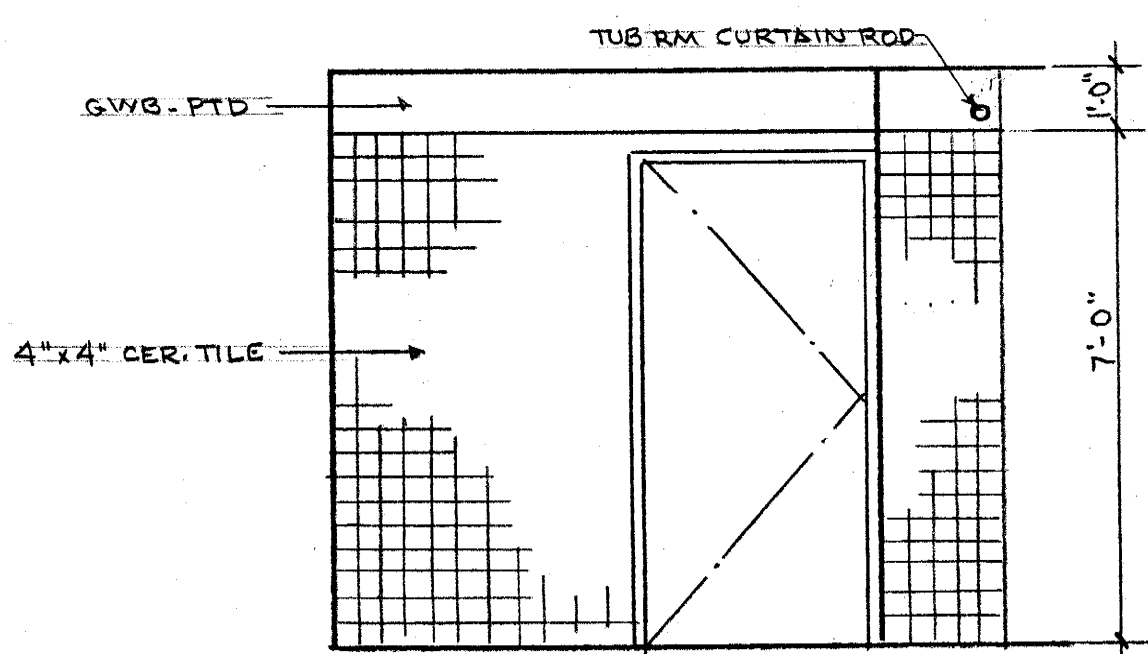

6